

Solar Panel Energy
Tel 083 544 2484 / 084 442 4235
Fitzsimons St 52, SE6
Vanderbijlpark, South Africa

enerSol
by **SD**DirectPro



EnerSol 15

+ 0/+5 WP POSITIVE TOLERANCE

🏠 OFF-GRID USE

✓ HIGH QUALITY

25 year linear performance warranty
10 year product warranty



enerSol

High quality solar panels
designed for off-grid use



EnerSol 15

General characteristics

Cell	polycrystalline solar cell 52 x 52 mm
No. of Cells (Connections)	36 (6x6)
Panel Dimensions	375 x 365 x 17 mm
Weight	1.7 kg
Connectors and Cables	Available upon request

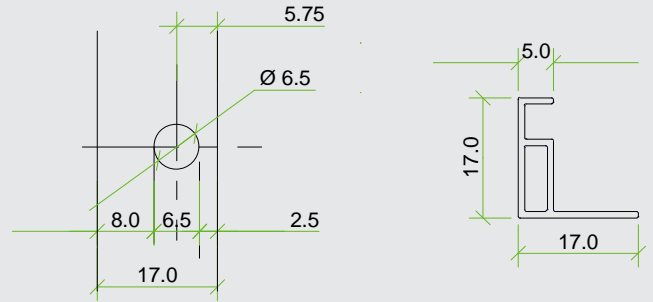
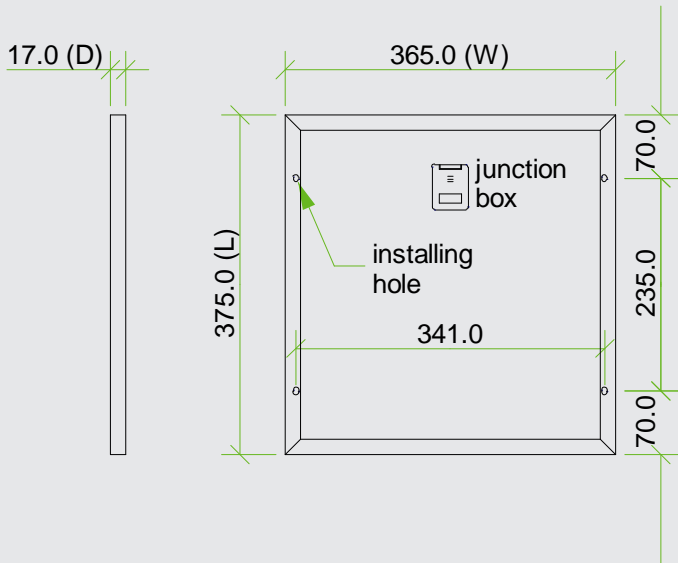

Thermal conditions

Normal Operating Cell Temperature 800W/m ² Irradiance, 20°C, AM = 1.5	48°C ± 2°C
Power Temperature Coefficient	- 0.5%/K
Current Temperature Coefficient	0.035%/K
Voltage Temperature Coefficient	- 0.37 MV/K

Limits

Operating Temperature	- 40°C to 85°C
Maximum System Voltage	1000V DC

Electric performance at STC *

Maximum Power	15 Wp
Power Tolerance	0/+5 Wp
Maximum Power Voltage	18 V
Maximum Power Current	0.83 A
Open Circuit Voltage	21.4 V
Short Circuit Current	0.92 A

*Standard Test Conditions : 1000W/m² irradiance, 25°C and AM = 1.5

High performance

25 25 Years
linear performance

10 10 Years
product warranty

